

Mounted Sprayers

BEYNE



Company

Beyne was founded in 1974 by Marcel Beyne and has been known for more than 40 years for its quality and durability. All Beyne agricultural sprayers are tailored to the specific needs and wishes of our customers.

Our company is in full expansion and has its focus on the latest developments in the field of mounted, trailed and self propelled sprayers. We are constantly looking to improve through new designs, advanced materials and more efficient production methods. We follow the latest technologies and innovations, such as GPS and other instruments for accurate farming, provided by Müller Elektronik.

Our experienced staff are happy to advise & help you in the selection of the appropriate sprayer for your business. Do not hesitate to contact us if you have any questions or require further information.

Our mounted sprayers

This catalog offers you a summary of our mounted sprayers: ranging from 600 liters to 1.800 liters with a spray boom width of 15 m to 28 m.

Beyne NV • Industriestraat 27 • 8480 Ichtegem • Belgium
Tel +32 (0)51-58.85.34 • Fax +32 (0)51-58.21.73
www.beyne.com • info@beyne.be



Inhoud

Summary of mounted sprayers	4-5
PA manual (15-18 m / 600-1.000 l)	6
PLH hydraulic (16-21 m / 600-1.000 l)	7
PLK hydraulic super (18-24 m / 800-1.200 l)	8-9
GECKO PLK (21-28 m / 1.500 l)	10-11
GECKO (18-28 m / 1.000-1.800 l)	12-15
Spray booms + possible options	16-17
Beyne Paint quality	18-19
SPRAYMAT II	20
Command box electrical sections	20
SPRAYLIGHT	20
SPRAY-Control S	21
SECTION-Control BOX	21
TRACK-Guide II	22
TRACK-Guide III	22
BASIC-Terminal	23
COMFORT-Terminal	23
Joystick	23
Touch screen: Touch 800	24
Touch screen: Touch 1200	24
Automatic section control via satellite	25
Distance Control	25
Manual command of the spray sections (S-box)	25
Air lockable caps with semi-continuous circulation	26
Automatic steering	27
Suspension Beyne spray boom	28
Struts & locking hooks	29-30
Technical information: dimensions & weights	31



PA



PA 15-18 m / 600-1.000 l

PLH



PLH 16-21 m



GECKO PLK 21-28 m / 1.500 l

Gecko

PLK



/ 600-1.000 l



PLK 18-24 m / 800-1.200 l



GECKO 18-28 m / 1.000-1.800 l



PA manual 15-18 m / 600-1.000 l

Spray boom width	15 m / 16 m / 18 m
Suspension spray boom	Self-stabilizing swing frame
Tank	600 l / 800 l / 1.000 l (with a reserve of 5% for foam)
Pump	Van 120 l/min to 165 l/min
Command	Manual valves, electrical valves (black box) in option
Height regulation	Hydraulic height adjustment without control block, control block in option
Additional options	Hydraulic balance adjustment, nitrogen accumulator on height adjustment, etc.
Spray caps	Uni-jets or tri-jets with anti-drip
Mixing tank	Extendable mixing tank with fust cleaner
Pressure regulation	Pressure regulator with compensation regulation
Filters	Suction filter, self-cleaning pressure filter
Manometer	Large manometer with glycerine
Paint quality	Sandblasted, metallised and powder coated (heated to 220 °)
(Re)placement	Support legs, lower link shaft
Options	Road lighting with signalisation, beacon, camera on (seperate) screen, etc.
Suction hose	6 m (with stainless steel suction strainer)
Clean water tank	80 l
Hand wash tank	20 l
Length	1,5 m
Width	3 m
Height	2,3 m
Weight	From 550 kg

PLH hydraulic 16-21 m / 600-1.000 l

Spray boom width	16 m / 18 m / 21 m
Spray boom	Fully hydraulic opening and closing of the spray boom
Suspension spray boom	Self-stabilizing swing frame, suspended on nitrogen accumulator
Tank	600 l / 800 l / 1.000 l (with a reserve of 5% for foam)
Pump	165 l/min, in option: 120 l/min or 196 l/min
Command	With preselection or completely electrohydraulic
Spray computer	In option: SPRAYLIGHT / SPRAY-Control S / ECO / ISOBUS
Spray circuit	Closed flushing system for the spray lines for easy rinsing
Spray caps	Quadri-jets with anti-drip or air lockable caps
Mixing tank	Extendable mixing tank with fust cleaner
Pressure regulation	Pressure regulator with compensation regulation
Tank level	In option: electronic tank level meter with or without display
Lighting	Road lighting with signalisation, in option: beacon (LED), work lights (LED or LED Trilliant)
Paint quality	Sandblasted, metallised and powder coated (heated to 220 °)
(Re)placement	Support legs, three point hitch
Suction hose	6 m (with stainless steel suction strainer)
Clean water tank	80 l
Hand wash tank	20 l
Length	3,5 m
Width	2,7 m
Height	3 m
Weight	From 800 kg



PLK hydraulic (18-24 m / 800-1.200 l)

Spray boom width	18 m / 21 m / 24 m
Spray boom	Fully hydraulic opening and closing of the spray boom, separate opening and closing of the tops, command of the spray boom by means of preselection
Suspension spray boom	Self-stabilizing swing frame, suspended on nitrogen accumulator
Tank	800 l / 1.000 l / 1.200 l (with a reserve of 5% for foam)
Pump	165 l/min, in option: 196 l/min
Command	With preselection or completely electrohydraulic
Spray computer	In option: SPRAYLIGHT / SPRAY-Control S / ECO / ISOBUS
Spray circuit	Closed flushing system for the spray lines for easy rinsing
Spray caps	Penta-jets with anti-drip or air lockable caps
Mixing tank	Extendable mixing tank with fust cleaner
Pressure regulation	Pressure regulator with compensation regulation
Tank level	In option: electronic tank level meter with or without display
Lighting	Road lights (LED) with signalisation, in option: beacon (LED), work lights (LED or LED Trilliant)
Paint quality	Sandblasted, metallised and powder coated (heated to 220 °)
(Re)placement	Support legs, three point hitch
Clean water tank	80 l tot 120 l
Suction hose	6 m (with stainless steel suction strainer)
Length	3,85 m
Width	2,7 m
Height	2,8 m
Weight	From 1.100 kg





Work lights (LED)



Locking hooks



Variable geometry



Tank fill meter

GECKO PLK (21-28 m / 1.500 l) spray boom PLK

Spray boom width	21 m / 24 m / 27 m / 28 m
Spray boom	Fully hydraulic opening and closing of the spray boom (sideways), electrohydraulic command of the spray boom
Suspension spray boom	Spray boom on mast, suspended on nitrogen accumulator
Tank	1.500 l (with a reserve of 5% for foam)
Pump	165 l/min, in option: 196 l/min or 225 l/min
Command	With preselection or completely electrohydraulic
Spray computer	SPRAY-Control S, in option: SPRAYLIGHT / ECO / ISOBUS
Spray circuit	Closed flushing system for the spray lines for easy rinsing
Spray caps	Penta-jets with anti-drip or air lockable caps
Mixing tank	Extendable mixing tank with fust cleaner
Pressure regulation	Pressure regulator with compensation regulation
Tank level	In option: electronic tank level meter with or without display
Lighting	Road lights, in option: beacon (LED), work lights (LED or LED Trilliant)
Paint quality	Sandblasted, metallised and powder coated (heated to 220 °)
(Re)placement	Fixed pickup system, three point hitch in option
Suction hose	6 m (with stainless steel suction strainer)
Clean water tank	165 l
Length	3,85 m
Width	2,65 m
Height	3,05 m
Weight	From 1.400 kg





Command pannel



Fixed pickup system



Three point hitch



GECKO (18-28 m / 1.000 - 1.800 l) Spray boom behind

Spray boom width	18 m / 20 m / 21 m / 24 m / 27 m / 28 m
Spray boom	Fully hydraulic opening and closing of the spray boom (behind)
Suspension spray boom	Self-stabilizing swing frame, suspended on nitrogen accumulator
Tank	1.000 l, in option: 1.300 l / 1.600 l / 1.800 l (with a reserve of 5% for foam)
Pump	165 l/min, in option: 196 l/min, in option: 225 l/min
Command	Electrohydraulic
Spray computer	SPRAY-Control S, in option: ECO / ISOBUS
Spray circuit	Closed flushing system for the spray lines for easy rinsing
Spray caps	Tri-jets with anti-drip or air lockable caps
Mixing tank	Extendable mixing tank with fust cleaner
Pressure regulation	Pressure regulator with compensation regulation
Tank level	In option: electronic tank level meter with or without display
Lighting	Road lights, in option: beacon (LED), work lights (LED or LED Trilliant)
Paint quality	Sandblasted, metallised and powder coated (heated to 220 °)
(Re)placement	Fixed pickup system, three point hitch in option
Suction hose	6 m (with stainless steel suction strainer)
Clean water tank	165 l
Length	2,0 m
Width	2,5 m
Height	2,85 m
Weight	From 1.500 kg





Air lockable caps



BASIC-Terminal





ISOBUS or ECO possible

SPRAY BOOMS + POSSIBLE OPTIONS

Spray booms GECKO

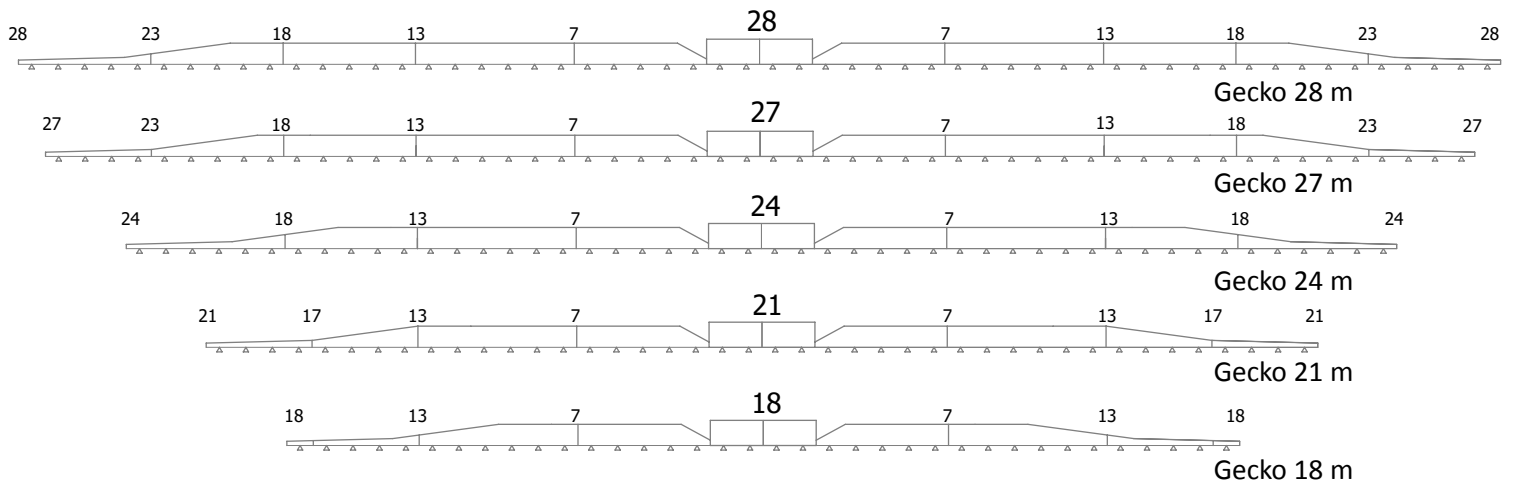

Spray booms GECKO-PLK + PLK

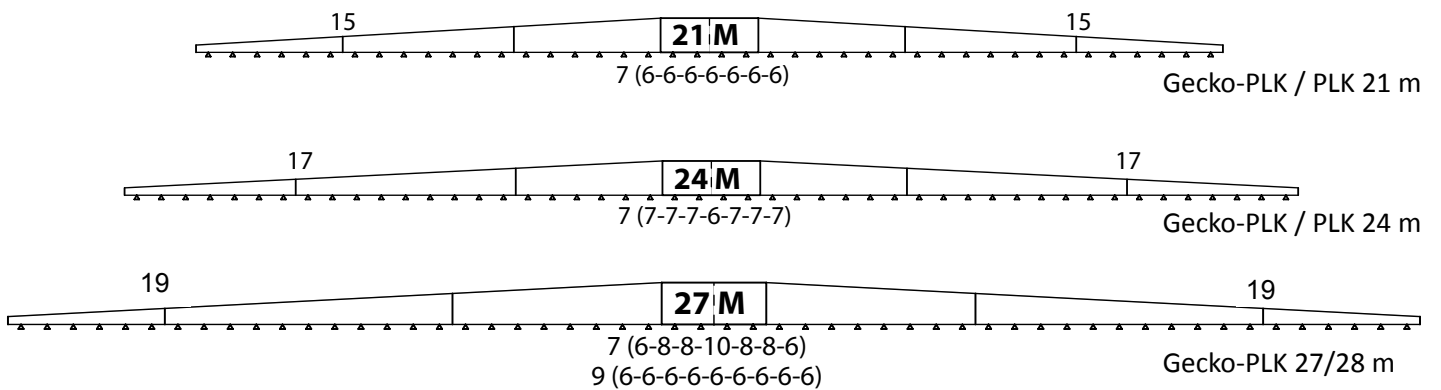



Command panel



Three point hitch



ISOBUS in option

Fronttanks



Fronttank of 1100 l



Fronttank of 750 l
with clean water tank



Pump 120 l/min
+ hydromotor

Air lockable caps with semi-continuous circulation



Tank with overpressure safety



Compressor and pump



Air tube per cap

BEYNE PAINT QUALITY

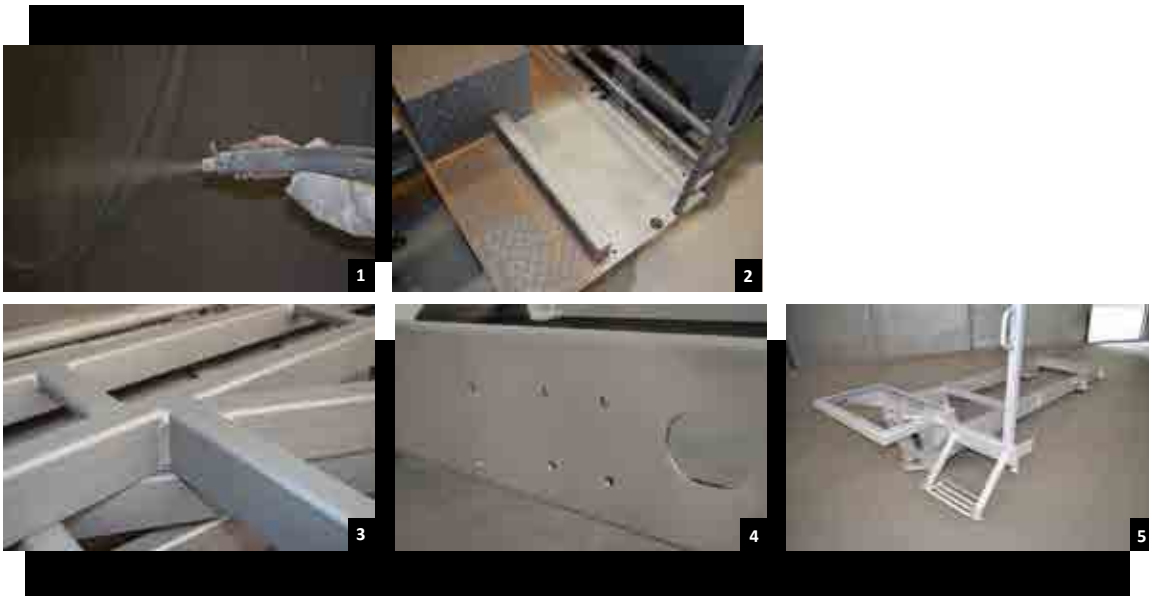

Blank steel

All metal parts are treated by a special procedure to obtain an outstanding paint quality.

1. Sandblasting

The parts are first sandblasted to remove the rust and to make sure that the bedding is uneven to guarantee an optimum adhesion of the metallisation and the powder coating. The parts are metallised immediately after the sandblasting.

Sandblasted



2. Metallisation:

The zinc wire, consisting of 85% zinc and 15% aluminium, is sprayed onto the blank metal at a temperature of 1900°C. This creates a layer of at least 40 µm which covers the whole part. This zinc layer prevents the appearance of rust. In case of a scratch, the paint won't peel off, thanks to the high adhesion of the zinc layer to the metal.



Zinc wire 85% zinc

Metallisation

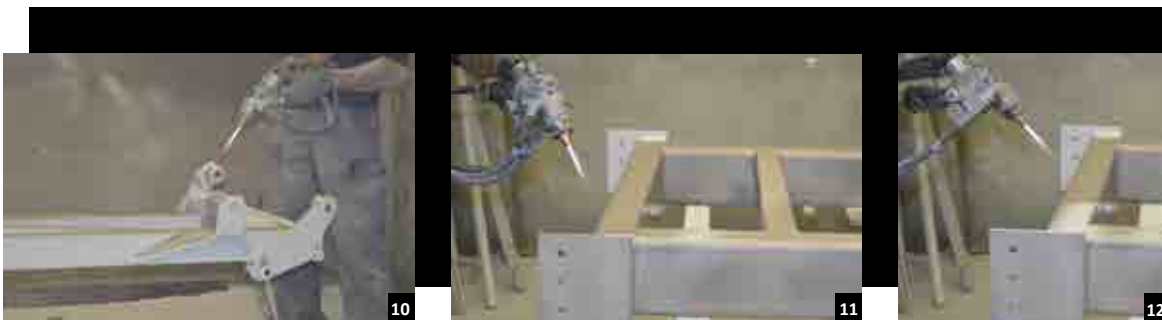

18

Metallisation

Minimal thickness of 40 µm

Powder Coating



3. Powder coating:

The parts are then suspended and positively charged. The powder is negatively charged and sprayed onto the metal, which results in an even distribution, ensuring the powder also covers hard-to-reach areas.



The coating is at least 120 μm thick. Together with the metallisation, this provides a layer thickness of at least 160 μm .

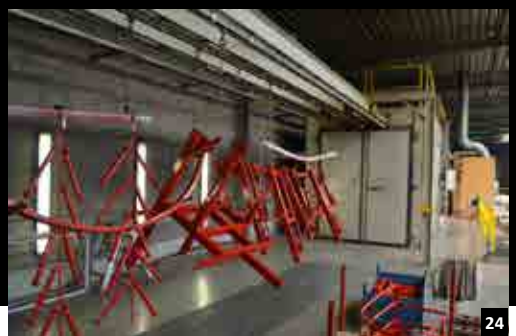

4. Baking

The parts are then baked in an oven of 215°C. This procedure ensures that we achieve a very high paint quality which is also resistant to liquid fertilisers.

SPRAY COMPUTERS / CONTROL BOXES



SPRAYMAT II

- Solid & user friendly counter for hectares, volume and speed.
- Included: flow meter and speed sensor.
- Can't be used to operate the machine.



Command box electrical sections :

- Command box to turn the sections on and off electrically.
- The desired spraying pressure can be controlled.
- The hydraulic functions can also be controlled, both by preselection as completely electrohydraulic.
- In option, the pressure can also be read on the display of the command box.
- No spray computer.



SPRAYLIGHT

- Solid, compact and user friendly spray computer.
- Controlled by 3 menu screens.
- Sections can be turned off sequentially (and individually through another menu).
- Maximum 7 sections + 4 additional functions (3 hydraulic + 1 extra).
- **Can only be used in combination with preselection.**

SPRAY-Control S



- Robust control panel + spray computer for full control of the machine.
- Both with preselection as electrohydraulic.
- All spray sections can be turned on and off via a separate switch.
- Desired spray rate can be easily entered.
- Unlimited amount of hydraulic functions.
- Maximum 12 sections + electrical side caps.
- Electric flushing valves possible.
- Air lockable spray caps possible.
- Ability to link with GPS TRACK-Guide II or III, optionally with automatic section control.



TRACK-Guide II



TRACK-Guide III

SECTION-Control Box

Automatic section control in combination with SPRAY-Control S.

The SECTION-Control Box allows us to equip agricultural sprayers that already have SPRAY-Control S, with automatic section control via GPS. Besides the SECTION-Control Box, you will also need a TRACK-Guide II or III.

The equipment afterwards is simple and very comfortable, thanks to the “plug and play” principle. Simply connect the SECTION-Control box between your control panel and the TRACK-Guide II, provide a power cable and you are ready! The terminal takes over further control. You continue to do the control of the hydraulic functions via the existing control panel. With the SECTION-Control Box and the TRACK-Guide II, you have many expansion possibilities, so you are ensured of a machine that remains up to date in the future.



TRACK-Guide II



TRACK-Guide III



TRACK-Guide II

The TRACK-Guide II is a very powerful terminal for guidance systems, simple to use and truly robust. This terminal is almost indispensable for all your work on the field.

The TRACK-Guide II can be upgraded thanks to new software and a powerful electronic architecture.

Thanks to the upgrade-possibilities of the software, you have a terminal that always meets your needs and/or your new machines.

The TRACK-Guide II can also function as an ISOBUS terminal (ISO 11783), via an additional license.

Additional options are: automatic section control (sprayer), headland management, variable dosage of the spray liquid.



TRACK-Guide III - Touch screen

More than a guidance system!

The TRACK-Guide III is a guidance system of the latest generation, equipped with a touch screen that delivers a clear picture with a great ease of use.

The TRACK-Guide III can be upgraded with several options. You can equip it with automatic steering or transform it into an ISOBUS terminal with multiple functions and with SECTION-Control. Thanks to the upgrade-possibilities of the software, you now have a terminal that always meets your needs and/or your new machines.

Additional Options are: automatic section control (sprayer), automatic steering (hydraulic or on the steering wheel), headland management, variable dosage of the chemicals.

Verbinding met camera possible.



The TRACK-Guide II and the TRACK-Guide III are user-friendly systems that assist you in any type of field. You can save the contours of the field, the driving routes and enter obstacles. You can give a name to the fields and equipment you use. The work process can be interrupted & saved at any time, allowing you to continue spraying where you left off. The machine is displayed in the main window with a line and an arrow. In the upper part of the screen you can view the sections, the machine or the lightbar. It shows you when to open a section (blue) or when to close it (red), this is the SECTION-View function. The sprayed and unsprayed land is clearly visible. The headland management option allows you to treat the headland separately. You can adjust the track yourself. Try these GPS's and you'll be surprised by its efficiency and ease of use.

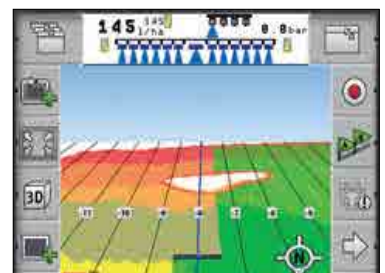
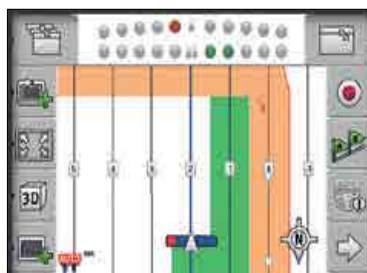



BASIC-Terminal (15cm)

- High quality ISOBUS-Terminal.
- Extensive upgrade-possibilities, yet easily operated.
- Full control of the sprayer is done via this screen.
- Optional: an integrated GPS for automatic section control.
- Very robust screen, with dustproof buttons.
- Terminal can be used to control other ISOBUS-machines.
- Terminal is ready for Precision farming.
- Many upgrade-possibilities:
 - Variable rate via cartography
 - GPS
 - ...



COMFORT-Terminal

- High quality ISOBUS-Terminal.
- Thanks to the large screen (26 cm diagonally) everything remains clearly visible.
- Extensive upgrade possibilities yet easy to control.
- Full control of the sprayer is done via this screen.
- Optional: an integrated GPS for automatic section control.
- Very robust screen, with dustproof buttons.
- Terminal can be used to control other ISOBUS-machines.
- Terminal is ready for Precision farming.
- Many upgrade-possibilities:
 - Variable rate via cartography
 - GPS
 - ...



Multi-functional joystick

The joystick is standard on ISOBUS machines. Thanks to this user-friendly joystick, the driver can pay more attention to the work ahead.

The joystick can be handled with ease.

With the aid of a switch on the side, the number of functions is tripled. Thus, it is possible to operate all common spray functions with the joystick. This way, the driver doesn't constantly have to change the functions through the terminal.

The joystick is robustly built and the buttons have been sealed dustproof.

!! For optimal ease of use !!

Touch screen: Touch 800



- High quality ISOBUS-Terminal.
- Thanks to the large screen (20 cm diagonally) everything remains clearly visible.
- Extensive upgrade possibilities yet easy to control.
- Full control of the sprayer is done via this screen.
- Optional an integrated GPS for automatic section control.
- Very robust screen, with dustproof buttons.
- Terminal can be used to control other ISOBUS-machines.
- Terminal is ready for Precision farming.
- Many upgrade-possibilities:
 - Automatic steering
 - Variable rate via cartography
 - Camera
 - ...

Touch screen: Touch 1200



- High quality ISOBUS-Terminal.
- Thanks to the large screen (31 cm diagonally) everything remains clearly visible.
- Extensive upgrade possibilities yet easy to control.
- Full control of the sprayer is done via this screen.
- Optional an integrated GPS for automatic section control.
- Very robust screen, with dustproof buttons.
- Terminal can be used to control other ISOBUS-machines.
- Terminal is ready for Precision farming.
- Many upgrade-possibilities:
 - Automatic steering
 - Variable rate via cartography
 - Camera
 - ...



Distance Control (optional):

- Automatic height adjustment of the spray boom (via the height, balance and variable geometry).
- This system works via 5 sensors:
 - 2 ultrasonic sensors to measure the height of the spray boom: left and right, always on the top lid.
 - 1 sensor mounted on the chassis to measure the angle of the field.
 - 1 sensor on the centre of the spray boom to measure the corner of the spray boom.
 - 1 sensor on the balance cylinder.
- The driver adjusts the working height and the height when turning on the headland. The spray boom will then adjust accordingly to the desired height, by controlling the height cylinder, the balance or the variable geometry.



Manual command of the spray sections (S-box):

- With a sprayer equipped with ISOBUS, you can only command the sections sequentially (from left to right or from right to left). You can turn off random sections only through a detour.
- However, if you would like to turn off random sections regularly, you better choose the S-box, which is connected directly to the terminal.
- The S-box can easily be installed afterwards.
- Max. 13 sections.
- Special S-box for 13-18 sections.



Automatic section control via satellite

- Thanks to the automatic section closure, unnecessary overlaps can be avoided. The terminal switches the sections itself, so you can spray more comfortably. Outside the field borders, the sections are closed automatically.
- You can drive both on DGPS (20-30 cm) as on RTK (2 cm + other antenne) .
- In combination with TOP-CONTROL, we can close cap by cap ourselves.
- Different spraying possibilities to lay several spray paths.
- Sufficient parameters to personalise the section closure.



AIR LOCKABLE CAPS WITH SEMI-CONTINUOUS CIRCULATION

Circuit during spraying (no return)

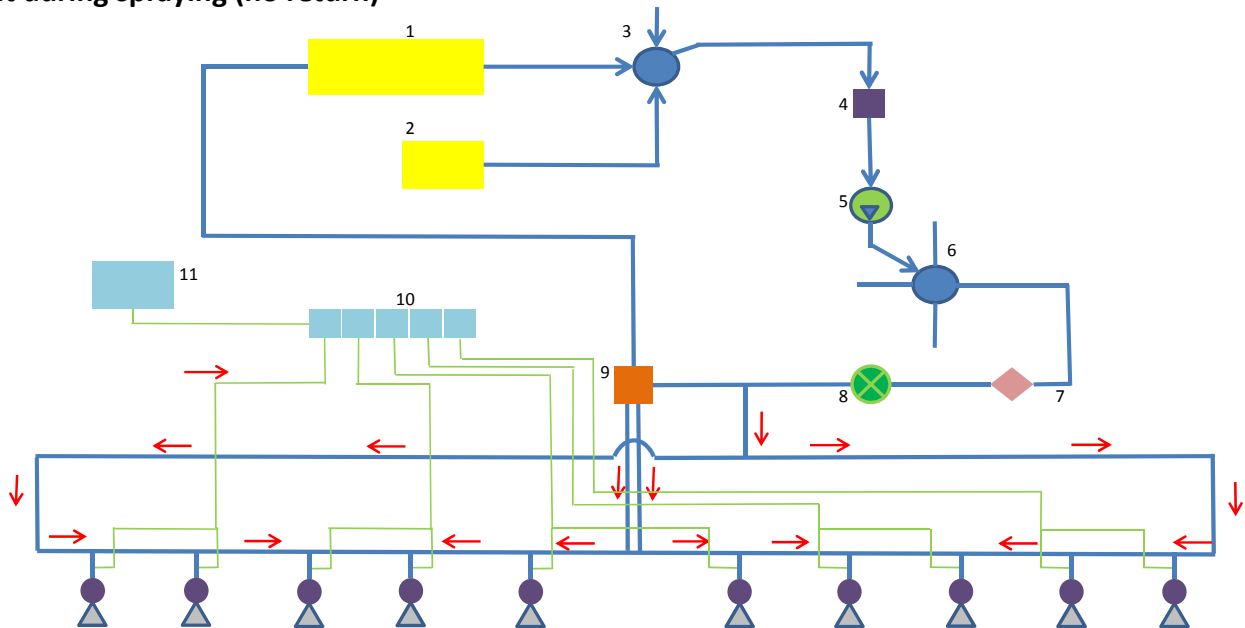

- | | |
|--------------------|-------------------------|
| 1 Master tank | 7 Pressure regulator |
| 2 Clean water tank | 8 Flow meter |
| 3 Suction valve | 9 Main valve |
| 4 Suction filter | 10 Section valves (air) |
| 5 Pump | 11 Air tank |
| 6 Pressure valve | |

Circuit during not spraying (circulation)

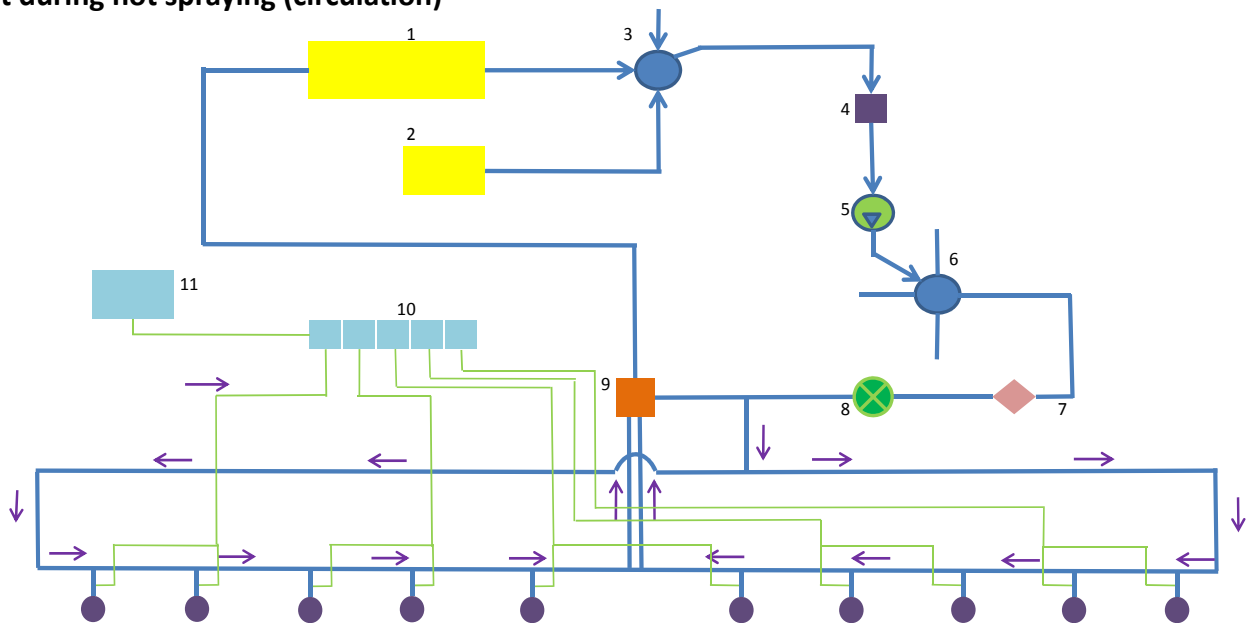

Advantages:

- Quick start after changing chemicals.
- No time wasted on the headland due to waiting for the chemicals reach the spray caps.
- No clogged spray caps, even with low doses.
- No dripping of the spray caps.
- No depositing of chemicals in the spray lines.
- Easy rinsing of the sprayer.
- Saves chemicals, time and money.
- Respects the environment.

Automatic steering

The automatic steering ensures precision farming by avoiding duplication or shortages, even with poor visibility or bad weather conditions. The automatic steering can be mounted on all touch screens. It relieves the driver of an often exhausting task.

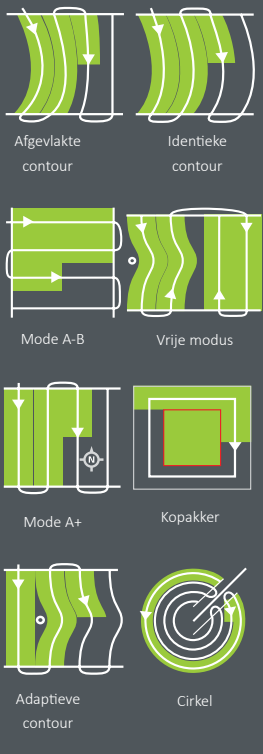

Automatic steering eSteer With motor on steering wheel



Automatic steering eSteer with motor on the steering wheel is the most cost-efficient automatic steering. The motor on the steering wheel is a quick and easy fix for pre-equipment. The eSteer can also be mounted on many different machines and can be easily moved to another machine. This device is mounted on the existing steering wheel. This compact electric motor controls the steering wheel directly.

Automatic steering With hydraulic bloc



Automatic steering with built-in hydraulic bloc is the most precise automatic steering. This system directly operates the hydraulic steering of the machine, causing it to stay in the spraying swath precisely. This system is ideal for machines that don't have pre-equipped automatic steering, especially when mainly repetitive work needs to be done.

Automatic steering ISO With pre-equipped hydraulic bloc



Automatic steering ISO is the system for precise hydraulic steering for machines that already have a hydraulic bloc for automatic steering. All it takes is to attach the steering computer to the terminal of the tractor. The communication of the components takes place via ISOBUS, which allows the system to be placed in a minimum amount of time.



	Correction signal	A101 (L1)	AG-STAR (L1)	SMART-6L (L1/L2)
EGNOS/WAAS	Free	20-25 cm	20-25 cm	15 cm
GL1DE	Free	/	25 cm	15 -18 cm
RTK	Payed	/	/	2 cm
Glonass	Free	No	Yes	Yes

For information purposes only, non-binding and subject to alterations / misprints.

SUSPENSION BEYNE SPRAY BOOM



Anti-oscillation

The suspension of the boom is obtained by the following points:

1. The boom is suspended by 1 central point. This point rests on a curved conduction, which makes the boom return to the same center point each time.
2. Due to the trapezium suspension, the spray boom can also move lateral, which guarantees that shocks won't cause oscillation. The spray boom stays horizontal and will make gentle, lateral movements.
3. On the central point rests a sliding bar, guided by Ertalon rolls. By controlling the cylinder, the center of gravity of the spray boom can be moved, which allows the spray boom to tilt to both sides, without blocking.

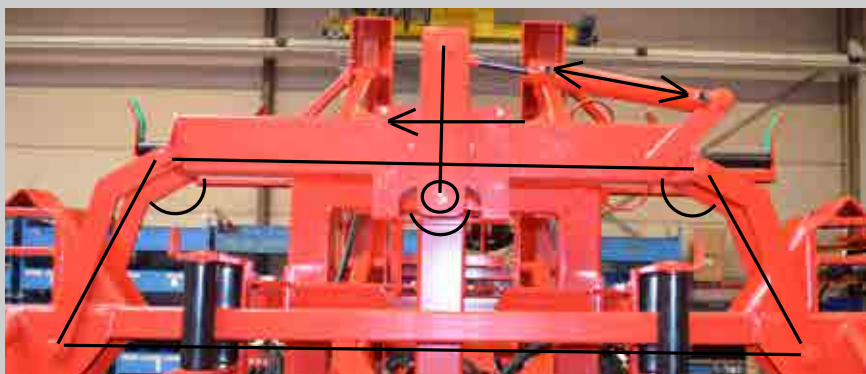

Anti-wagging

1. During wagging, the spray boom hinges on 1 point.
2. Both with parallelogram-suspension as with mast-suspension, silentblocs were placed between the chassis and the spray boom to prevent wagging.
3. Due to the absorption of the silentblocs, the shocks of the tractor aren't passed on to the spray boom, which results in a very stable spray boom.



The guiding of the moving parts is done by Ertalon rolls. This is a strong and durable material which doesn't damage the spray boom.





STRUTS & LOCKING HOOKS

The spray boom stays straight thanks to struts:

- The struts connect the 2nd segment to the right with the 2nd segment to the left of the spray boom.
- When swaying, the forces are evenly distributed on the entire spray boom which keeps the spray boom straight.
- The insertions tubes are designed so that the spray boom doesn't break due to large forces, instead they bend.
- After years of intensive use, the spray boom remains straight thanks to several points where the spray boom can be adjusted.

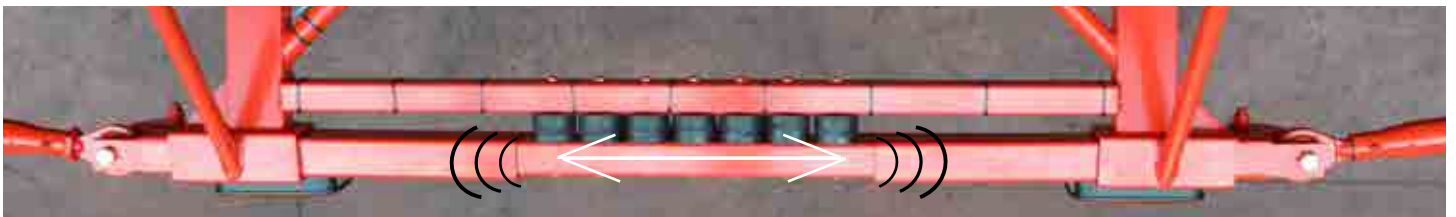

The shocks are absorbed in the central part due to the qualitative silentblocs made out of natural rubber.

Beyne spray booms

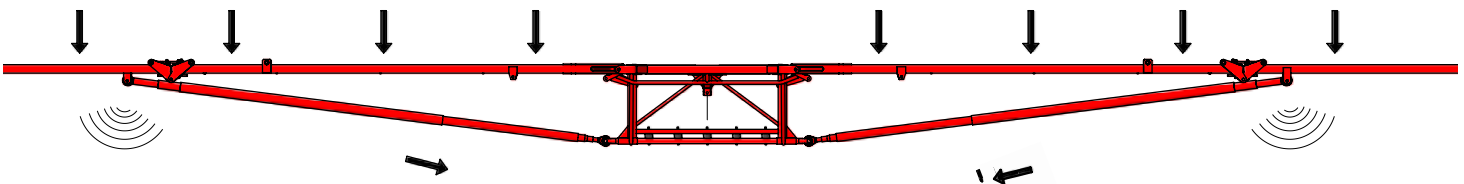

Spray booms without struts & locking hooks

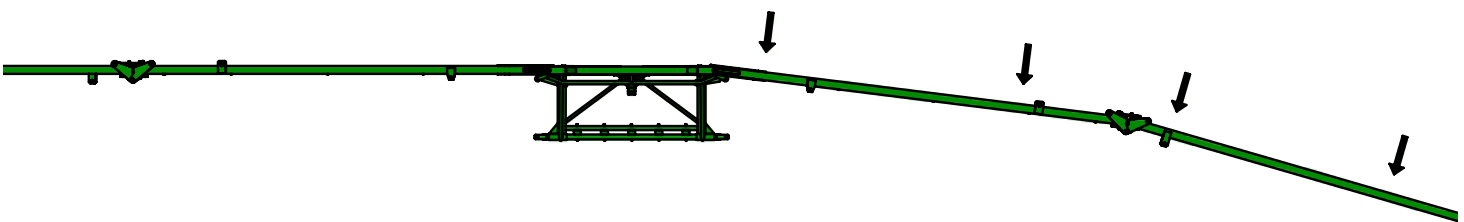

Locking of the spray boom

- Between the 1st and 2nd segment and the top end, there are locking hooks.
- These locking hooks prevent that the forces of sway movements influence the hydraulic cylinders, so they won't break.
- The locking hooks click into full RVS-axes which are excentric. If after some time some wear would occur, these axes can be adjusted, so the boom remains tight always.
- The locking hooks are hydraulically controlled, as well as the opening and closing of the spray boom.
- The locking hooks are equipped with grease nipples, like all other hinge points.





Hinge points

All hinge points consist of full RVS-axes, containing sintered bronze hinges and equipped by easy to reach grease nipples.

TECHNICAL INFORMATION: DIMENSIONS & WEIGHTS

	<i>Width (mm)</i>	<i>Height (mm)</i>	<i>Length (mm)</i>	<i>Weight (mm)</i>
PA 15-16	2800	2300	1500	550
PA 18	3000	2300	1500	600
PLH 16-18	2700	2750	3000	800
PLH 21	2700	3000	3500	850
PLK 18-21	2700	2800	3850	1100
PLK 24	2700	2800	4350	1125
Gecko PLK 21	2650	3050	3850	1400
Gecko PLK 24	2650	3050	4350	1425
Gecko PLK 27-28	2650	3300	4850	1500
Gecko 18	2500	2850	2000	1500
Gecko 21	2500	2850	2150	1600
Gecko 24	2500	2850	2300	1650
Gecko 27-28	2500	2850	2400	1750

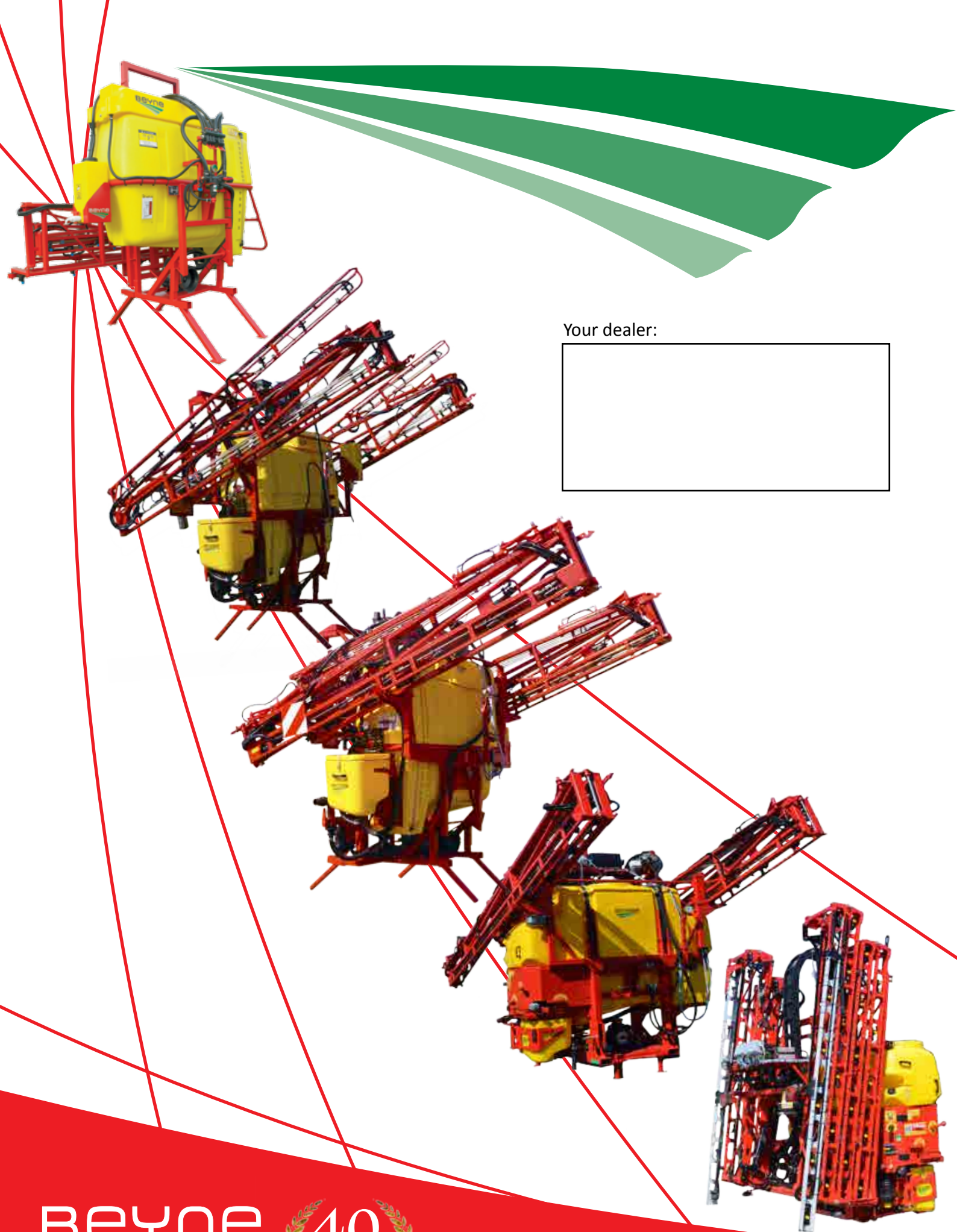

Your dealer:

BEYNE

40

